

# CAROLINA

## 135 Degree Glass-to-Glass Hinge

ITEM NO. CLN135

ITEM NO. CLN535 (5 DEGREE FACTORY SET)

### SPECIFICATIONS

**Glass Sizes:** 3/8" to 1/2" (10 to 12 mm) Tempered Glass Only  
**Construction:** Solid Brass  
**Closing Type:** Self-Centering When Within 15 Degrees of Closed Position  
**Cutout Required:** Cutout No. SD39 and SD40  
**Includes:** Hinge, glazing gaskets, wall mounting screws, allen head/phillips head cover plate screws, and fabrication template.  
**Use:** Residential Bath and Commercial Hotel Applications

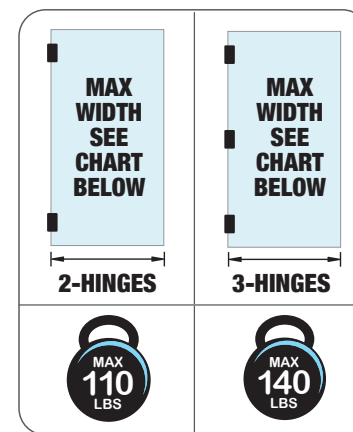
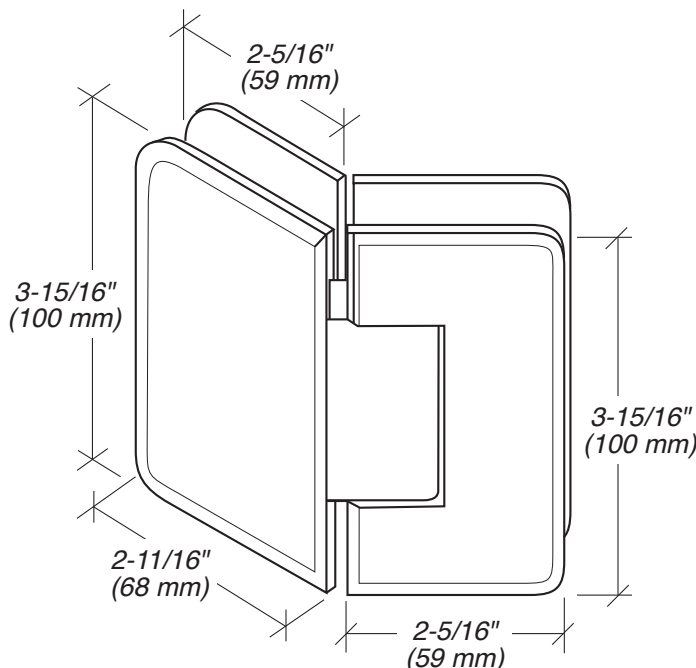

**SEE TEMPLATE ON BACK**  
 Refer to Dimensions Shown to Ensure Accuracy

### GASKET SPECIFICATIONS:

**For 3/8" (10mm) Glass:** Use One Thick Gasket On Each Side

**For 1/2" (12mm) Glass:** Use One Thin Gasket On Each Side

### GLASS INSTRUCTIONS:

Only use tempered safety glass. To prevent damage to the hinge finish during installation, do not use power tools when installing these hinges.

### IMPORTANT INFORMATION:

The Carolina Series Hinge has a dual degree pivot pin. It comes factory set at 90 degrees for normal door closing applications. There is also a secondary setting on the hinge pivot pin that can be field adjusted to allow an additional 5 degrees of closing for jobs that require a firmer positive position against a jamb or seal.

MAXIMUM DOOR CAPACITY	3/8" (10 mm) GLASS Approx. 5 lb/ft <sup>2</sup>	1/2" (12 mm) GLASS Approx. 6.4 lb/ft <sup>2</sup>
	DOOR WEIGHT	DOOR WIDTH
USING 2 HINGES	110 LBS. (50 kg)	36" (813 mm)
USING 3 HINGES	140 LBS. (64 kg)	36" (914 mm)

**NOTE:** Do not exceed either maximum weight or width when choosing proper quantity of hinges.

### CARE & CLEANING GUIDELINES:

For best results, keep the following recommendations in mind when caring for your FHC shower door hardware. Your shower door should be dried daily with a soft towel or cloth to ensure its original finish. Do not use harsh cleaners or chemicals on the hardware, as many of the components are coated with a clear lacquer that will become damaged beyond repair. Always test your cleaning solution in an inconspicuous area prior to cleaning the entire hardware surface. Wipe surfaces clean using a soft, dampened cloth or sponge, and rinse completely with warm water immediately after applying the cleaning solution. Use only small amounts of liquid, gentle, cleaner. Never use abrasive products, sponges, or wire scrub brushes while cleaning hardware.

### MAINTENANCE:

FHC's hinges come factory greased for a silent, hassle-free experience. If there is any noticeable squeaking that occurs after installation it is recommended to apply a few drops of (3 in 1) multi-purpose oil to the hinge, at the nylon washer/pivot location. The lubricant will penetrate the hinge crevices, reducing friction, cleaning grime, and/or buildup. Spray lubricants are prohibited. If, for some reason, the hinge is disassembled during maintenance, use a small amount of white lithium grease to lubricate the interior hinge components.



# CAROLINA

135 Degree Glass-to-Glass Hinge

ITEM NO. CLN135

ITEM NO. CLN535 (5 DEGREE FACTORY SET)



DO NOT MEASURE / SCALE DRAWING  
USE DIMENSIONS SHOWN

## PREFERRED "MOUSE-EAR" CUTOUT OPTION

Cutout No. SD39

DOOR TEMPLATE SQUARE CUT

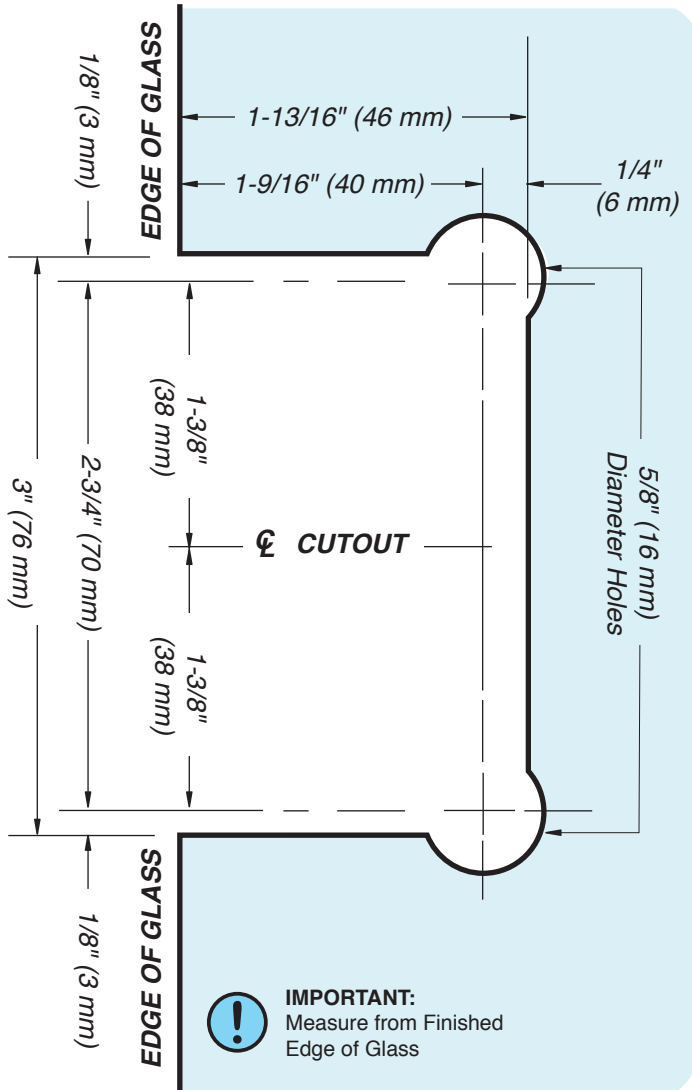

MITERED FIXED PANEL TEMPLATE 45° MITER

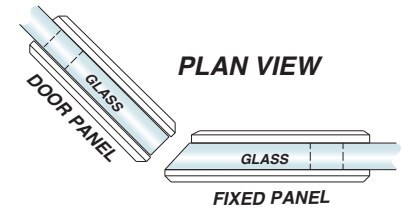
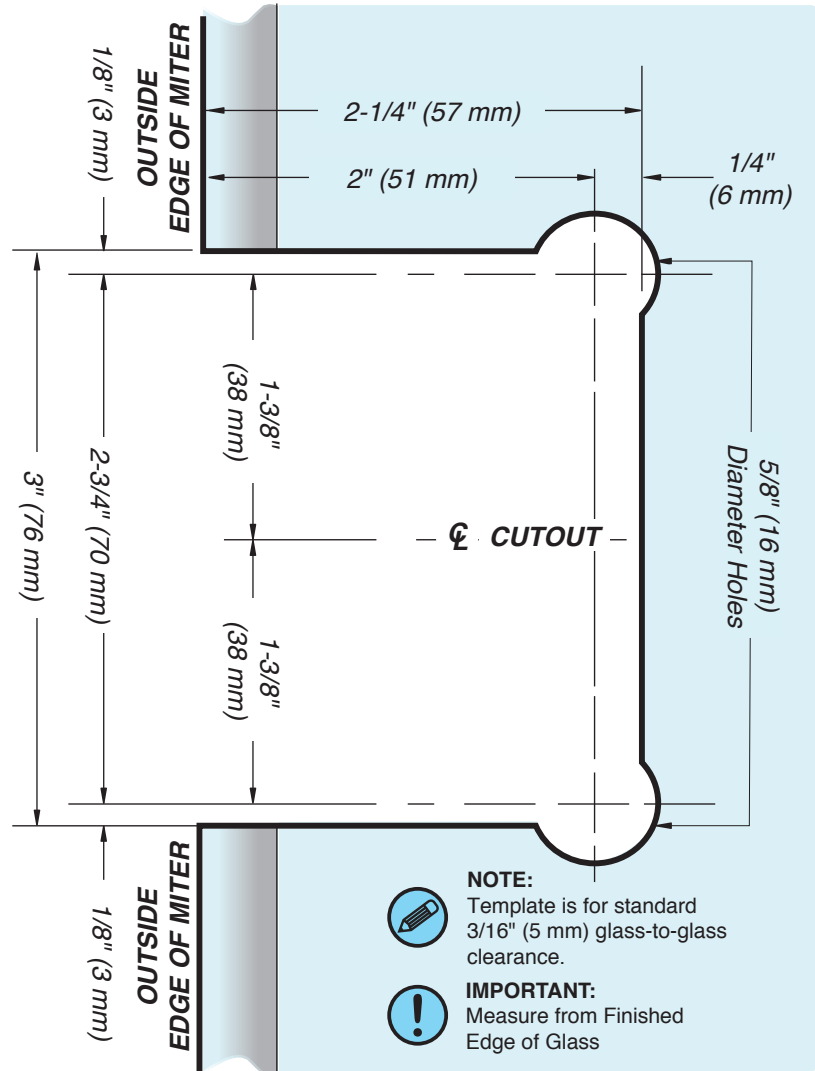

USE ONLY  
MONOLITHIC  
TEMPERED GLASS



For Technical Support  
Call Toll Free in the U.S.  
**(888) 295-4531**



**NOTE:**  
Template is for standard  
3/16" (5 mm) glass-to-glass  
clearance.



**IMPORTANT:**  
Measure from Finished  
Edge of Glass



**IMPORTANT:**  
Measure from Finished  
Edge of Glass

# CAROLINA

135 Degree Glass-to-Glass Hinge

ITEM NO. CLN135

ITEM NO. CLN535 (5 DEGREE FACTORY SET)



DO NOT MEASURE / SCALE DRAWING  
USE DIMENSIONS SHOWN

## RECTANGULAR CUTOUT OPTION

Cutout No. SD40

DOOR TEMPLATE SQUARE CUT

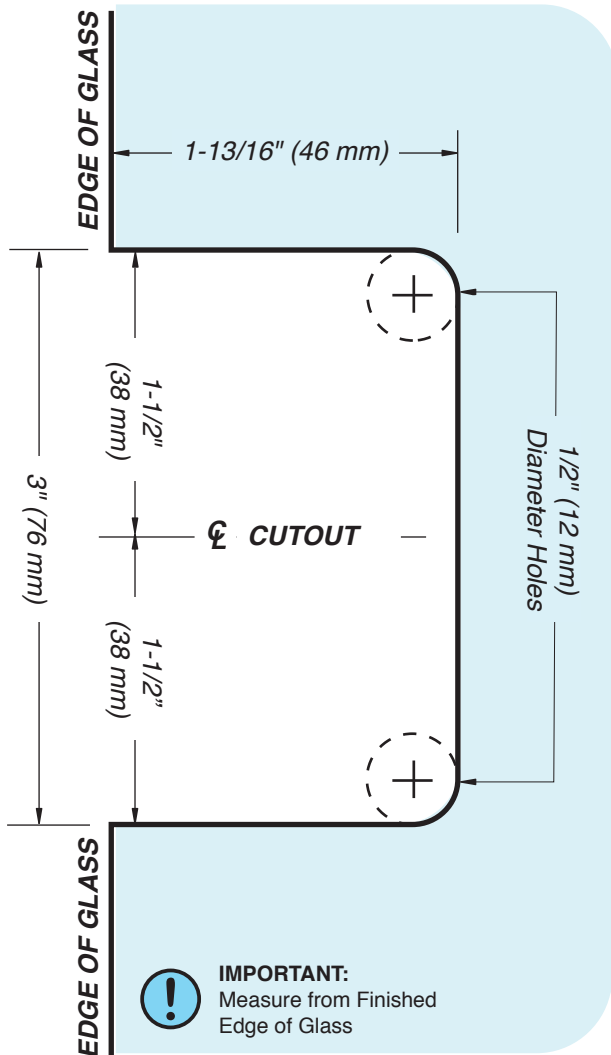

MITERED FIXED PANEL TEMPLATE 45° MITER

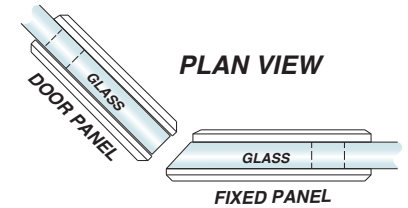
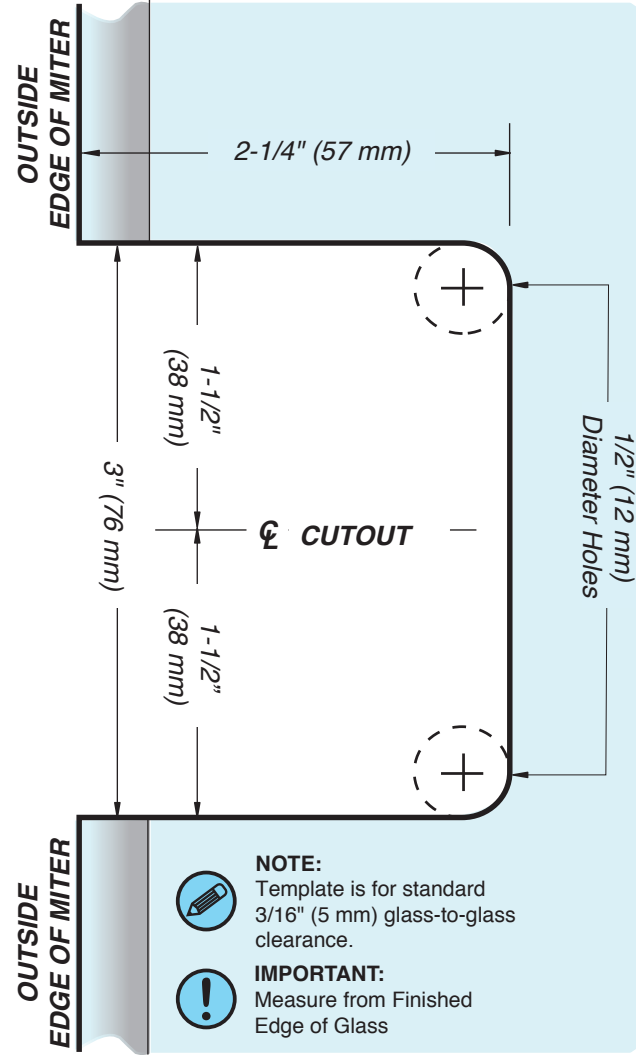

For Technical Support  
Call Toll Free in the U.S.  
**(888) 295-4531**

