

FHC-ADVANCE SERIES FRAMELESS GLASS ENTRANCE SYSTEM

Advance HERC-DOOR[™] Rail

2-1/2" Low Profile Tapered 12" Patch Rail 5/8" or 11/16" Tempered Glass

- Patent Pending UNITIZING GASKET / Dual-Inclined Control Surfaces
- Easiest and Fastest Patch Rail to Install in the Industry
- 60 Degree A.D.A Compliant Tapered Top Edge
- For 5/8" Monolithic Tempered and 11/16" Laminated Tempered Glass
- Class 1 Anodizing UV Stable Finishes That Will Not Fade
- Increased Glass Bite Improves Holding Strength and Aesthetics
- Solid One Piece Aluminum Housing
- State of the Art Solid Forged Brass Plated End Caps With Premium Finishes
- New Innovative Anti-Clamshell Pad End Cap
- Available With or Without Lock
- Available In a Wide Range of Architectural Finishes
- Accepts Standard Size Mounting Hardware

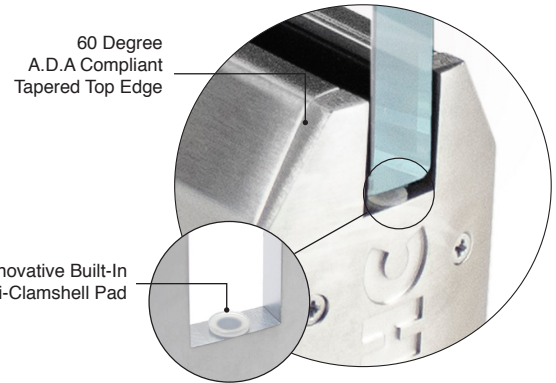
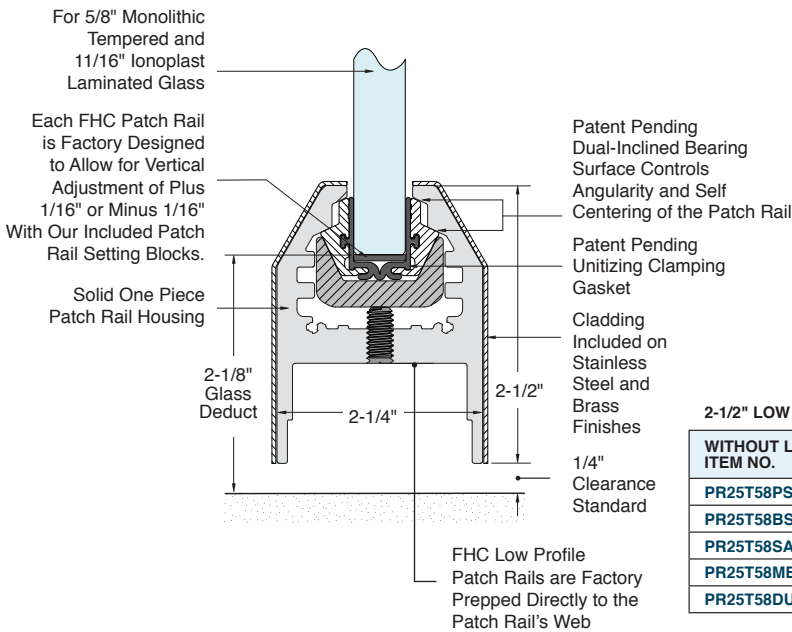

2-1/2" LOW PROFILE TAPERED PATCH RAILS 12" LENGTH - STOCK PRODUCTS

WITHOUT LOCK ITEM NO.	WITH LOCK ITEM NO.	DESCRIPTION
PR25T58PS	PR25T58PSL	Low Profile Tapered Patch Rail 12" Long Polished Stainless Steel
PR25T58BS	PR25T58BSL	Low Profile Tapered Patch Rail 12" Long Brushed Stainless Steel
PR25T58SA	PR25T58SAL	Low Profile Tapered Patch Rail 12" Long Satin Anodized
PR25T58MB	PR25T58MBL	Low Profile Tapered Patch Rail 12" Long Matte Black (Powder Coat)
PR25T58DU	PR25T58DUL	Low Profile Tapered Patch Rail 12" Long Dark Bronze Anodized

CUSTOM LENGTH 2-1/2" LOW PROFILE TAPERED PATCH RAILS SPECIFICATION AS SUPPLIED BY CUSTOMER

WITHOUT LOCK ITEM NO.	WITH LOCK ITEM NO.	DESCRIPTION
PR25T58PSC	PR25T58PSLC	Custom Low Profile Tapered Patch Rail Length Polished Stainless Steel
PR25T58BSC	PR25T58BSLC	Custom Low Profile Tapered Patch Rail Length Brushed Stainless Steel
PR25T58SAC	PR25T58SALC	Custom Low Profile Tapered Patch Rail Length Satin Anodized
PR25T58MBC	PR25T58MBLC	Custom Low Profile Tapered Patch Rail Length Matte Black (Powder Coat)
PR25T58DUC	PR25T58DULC	Custom Low Profile Tapered Patch Rail Length Dark Bronze Anodized
PR25T58PTC	PR25T58PTLC	Custom Low Profile Tapered Patch Rail Length Custom Paint Color

PRODUCT INFO/SPECIFICATIONS:

- CSI Format Specifications are Available for Download
- End Caps are Included with Every Patch Rail
- Patch Rails With Locks are Supplied Prepped and Installed, Keyed Cylinders, and Thumbturns are Sold Separately
- FHC Follows GANA Guidelines for Maximum Door Height and Widths. Reference the FHC Herc-Door Sizing Guidelines.

CARE & CLEANING

Brushed Stainless Steel, Polished Stainless Steel or Class 1 Anodized Finishes should be cleaned with a foam spray cleaner, such as: FHC GW19 Ammonia Free Cleaner. GW19 cleaner will assist with removing fingerprints, grease and water splatter. GW19 cleaner will also preserve the durable factory finish and can be wiped with a clean, dry cloth. FHC Lint Free Shop Wipes FHC3255 are recommended. These high performance wipes maintain their strength wet or dry and will not scratch the surface.



For Technical Support
Call Toll Free in the U.S.
(888) 295-4531

