

FHC-ADVANCE SERIES FRAMELESS GLASS ENTRANCE SYSTEM

Advance **HERC-DOOR**™ Rail

4" Square 12" Patch Rail 5/8" or 11/16" Tempered Glass

- Patent Pending UNITIZING GASKET / Dual-Inclined Control Surfaces
- Easiest and Fastest Patch Rail to Install in the Industry
- New Modern Crisp Corner Design
- For 5/8" Monolithic Tempered and 11/16" Laminated Tempered Glass
- Class 1 Anodizing UV Stable Finishes That Will Not Fade
- New Improved Pivot Alignment System "PAS" Included With Each Rail
- Increased Glass Bite Improves Holding Strength and Aesthetics
- Solid One Piece Aluminum Housing
- State of the Art Solid Forged Brass Plated End Caps With Premium Finishes
- New Innovative Anti-Clamshell Pad End Cap
- Available With or Without Lock
- Available In a Wide Range of Architectural Finishes



For 5/8" Monolithic Tempered and 11/16" Ionoplast Laminated Glass

Each FHC Patch Rail is Factory Designed to Allow for Vertical Adjustment of Plus 1/8" or Minus 1/16" With Our Included Patch Rail Setting Blocks.

Solid One Piece Patch Rail Housing
PAS Pivot Alignment System With Hardware Mounting Block Allows 3/8" Adjustments

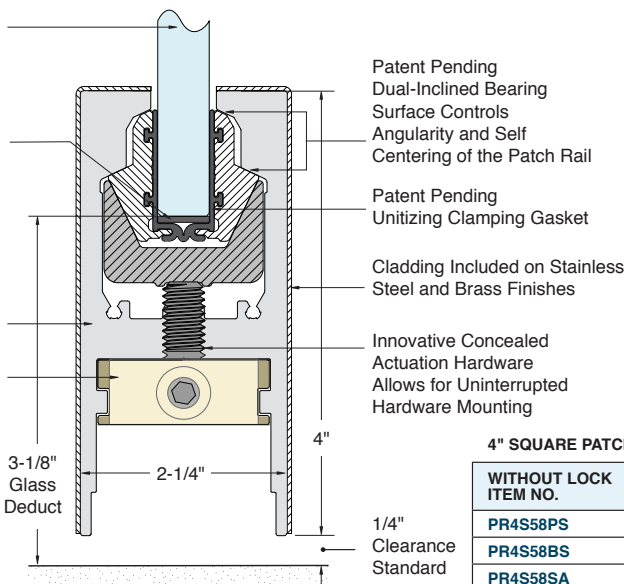

New Modern Crisp Corner Design

New Innovative Built-In Anti-Clamshell Pad

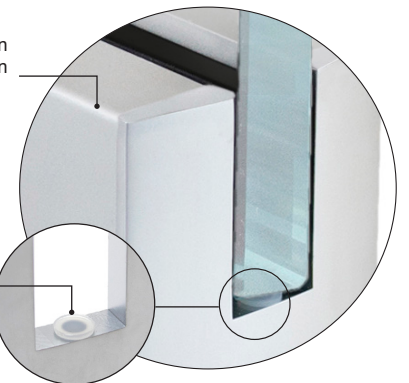

4" SQUARE PATCH RAILS 12" LENGTH - STOCK PRODUCTS

WITHOUT LOCK ITEM NO.	WITH LOCK ITEM NO.	DESCRIPTION
PR4S58PS	PR4S58PSL	Square Patch Rail 12" Long Polished Stainless Steel
PR4S58BS	PR4S58BSL	Square Patch Rail 12" Long Brushed Stainless Steel
PR4S58SA	PR4S58SAL	Square Patch Rail 12" Long Satin Anodized
PR4S58MB	PR4S58MBL	Square Patch Rail 12" Long Matte Black (Powder Coat)
PR4S58DU	PR4S58DUL	Square Patch Rail 12" Long Dark Bronze Anodized

CUSTOM LENGTH 4" SQUARE PATCH RAILS - SPECIFICATION AS SUPPLIED BY CUSTOMER

WITHOUT LOCK ITEM NO.	WITH LOCK ITEM NO.	DESCRIPTION
PR4S58PSC	PR4S58PSLC	Custom Square Patch Rail Length Polished Stainless Steel
PR4S58BSC	PR4S58BSLC	Custom Square Patch Rail Length Brushed Stainless Steel
PR4S58SAC	PR4S58SALC	Custom Square Patch Rail Length Satin Anodized
PR4S58MBC	PR4S58MBLC	Custom Square Patch Rail Length Matte Black (Powder Coat)
PR4S58DUC	PR4S58DULC	Custom Square Patch Rail Length Dark Bronze Anodized
PR4S58PTC	PR4S58PTLC	Custom Square Patch Rail Length Custom Paint Color

PRODUCT INFO/SPECIFICATIONS:

- CSI Format Specifications are Available for Download
- End Caps are Included with Every Patch Rail
- Patch Rails With Locks are Supplied Prepped and Installed, Keyed Cylinders, and Thumbturns are Sold Separately
- FHC Follows GANA Guidelines for Maximum Door Height and Widths. Reference the FHC Herc-Door Sizing Guidelines.

CARE & CLEANING

Brushed Stainless Steel, Polished Stainless Steel or Class 1 Anodized Finishes should be cleaned with a foam spray cleaner, such as: FHC GW19 Ammonia Free Cleaner. GW19 cleaner will assist with removing fingerprints, grease and water splatter. GW19 cleaner will also preserve the durable factory finish and can be wiped with a clean, dry cloth. FHC Lint Free Shop Wipes FHC3255 are recommended. These high performance wipes maintain their strength wet or dry and will not scratch the surface.



For Technical Support
Call Toll Free in the U.S.
(888) 295-4531

