

INSTALLATION INSTRUCTIONS

1510, 1570, 1580 SERIES EMLOCK®

The 1500 Series Emlock is mounted to the underside of the header, on the stop side of the door. A TJ mounting kit (optional) can be used when mounting on the hinge side of the door. (Fig. 1D)

The armature is mounted to the door. A hardware kit is provided to compensate for misalignment and wear of the door, by allowing the armature to pivot on it's center point.

1. Inspect the frame header to determine if an angle bracket or filler plate is required. See Figure 1A, 1B, 1C.

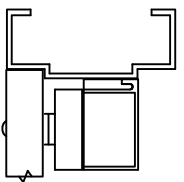

FIG. 1A
Regular

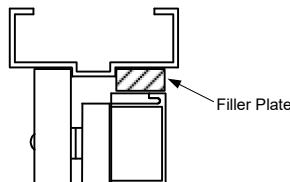

FIG. 1B
With Filler Plate

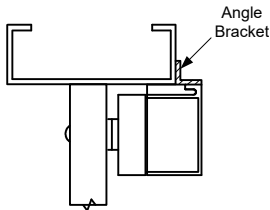

FIG. 1C
With Angle Bracket

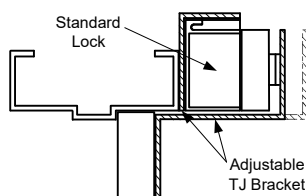

FIG. 1D
Top Jamb Installation

2. Fold template as indicated by dotted line. For single doors, locate template against the door and header on the lock jamb side of the frame.
3. Mark and drill holes as indicated by template. For armature plate hole preparation, see Figure 2A, 2B, 2C.
4. Mount armature to door. To determine proper hardware (provided), see Figure 2A, 2B, 2C.
5. Install mounting plate to header with the interlock detail away from the door side of the stop, with #10 Flt Hd. Screws provided.

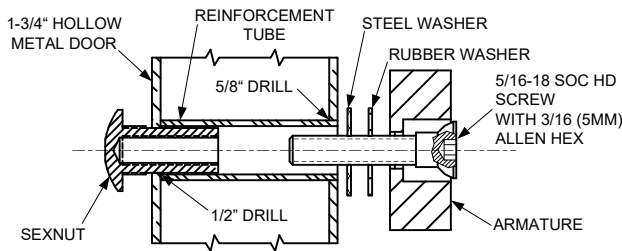

FIG. 2A HOLLOW METAL DOOR

From Sexnut side of door, drill exactly 1/2" hole thru one metal thickness only. From Armature side of door, drill 5/8" hole to insert reinforcement tube. Press in sexnut and reinforcement tube all the way and mount armature to door using hardware provided per Figure 2B.

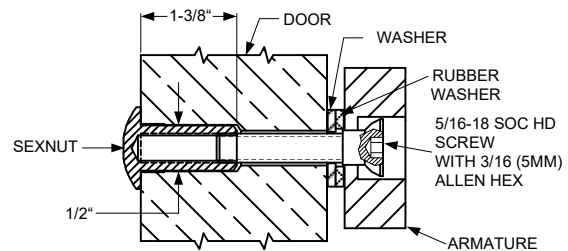

FIG. 2B SOLID DOOR

Drill 3/8" hole thru door. From sexnut side of door, drill exactly 1/2" hole, 1-3/8" deep. Mount armature to door with hardware provided per Figure 2A.

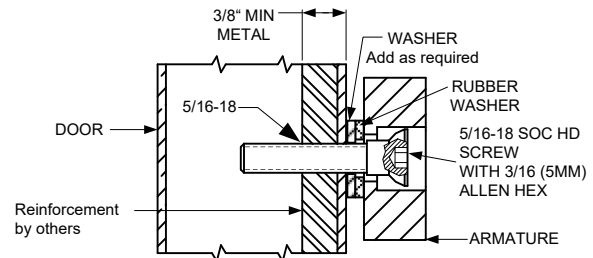

FIG. 2C REINFORCED DOOR

Drill and tap for 5/16-18 machine screw. Mount armature to door with hardware provided per Figure 2C.

6. Holding the magnet housing at each end, engage the entire length of the interlock detail, by pushing towards the door. (If necessary, tap with a soft hammer to ensure proper alignment and engagement).

Caution: The lock body must be held in place until secured with mounting screws. Screws provided inside the housing at each end. Tighten the screws and check alignment.

7. Test operation. When all is operating properly, tighten all screws. Install anti-tamper plugs over socket head screw using a soft hammer to avoid damage to the housing.

Electromagnet and armature should be handled carefully. Any damage to the surface such as paint, burrs, dirt and rust may hinder bonding of surface and reduce holding power.

SHOULD THE SURFACE PLATING BE DAMAGED:

Do not touch the lock face with your hands.

Using a soft, clean, dry cloth or abrasive cloth (i.e., Scotch-Brite), clean lock face. Do not use sand paper.

A rust inhibitor such as M1, manufactured by Starret, or LPS3, manufactured by LPS Laboratories (available at most hardware stores) can then be applied.

Apply a coat of inhibitor to armature face also.

OPTIONAL: 1511-DF DRILL FIXTURE

Drill many doors and frames in a fraction of the time.

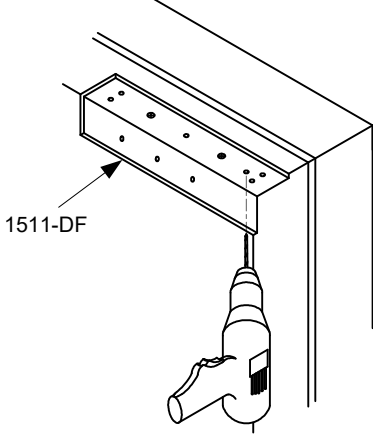

ELECTRICAL SPECIFICATIONS

Voltage kickback protection standard

SERIES	1510	1570	1580
INPUT VOLTAGE (VDC)	12/24	12/24	12/24
POWER CONSUMPTION (mA)	700/350	250/125	440/220
COIL RESISTANCE (OHMS)	35* (PER COIL)	100* (PER COIL)	60* (PER COIL)
HOLDING FORCE (LBS)	1650	1200	650

***NOTE:** For a proper coil resistance reading, turn off the DC voltage. Use an ohmmeter and measure the resistance between the pins of the plug connector positions E1-E2 and E3-E4

1510, 1570 SERIES CONNECTIONS

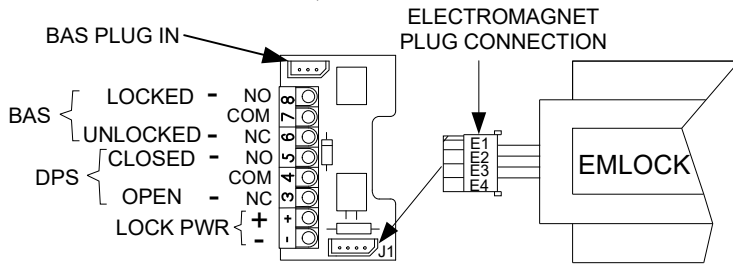

FIG. 3A

1580 SERIES CONNECTIONS

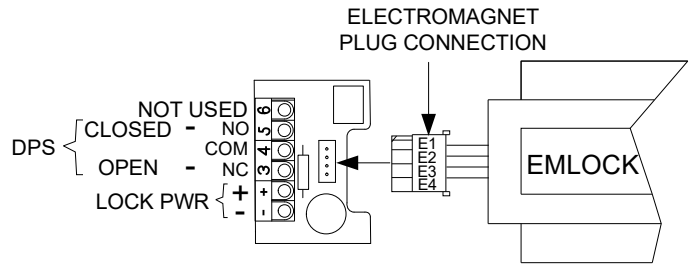
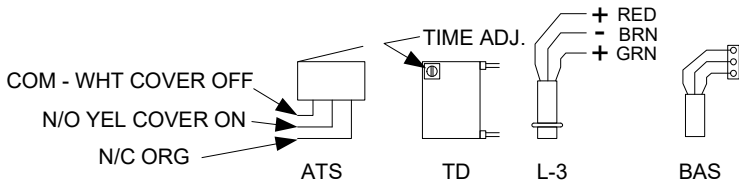
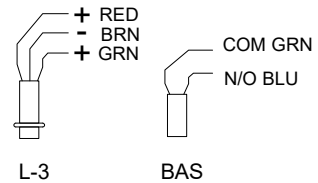

FIG. 3B



AVAILABLE OPTIONS

- | | | |
|------------|-----------------------------------|-------------------|
| ATS | Anti-Tamper Switch | SPDT, DRY, |
| BAS | Magnetic Bond Sensor | SPDT, DRY, |
| DPS | Door Position Switch | SPDT, DRY, |
| LED | Tri-Color LED Red or Green | 20 mA |
| | Both on = Yellow | 40 mA |
| TD | TIME DELAY (1-30 sec) | 20 mA |



AVAILABLE OPTIONS

- | | | |
|------------|-----------------------------------|----------------------|
| BAS | Magnetic Bond Sensor | SPST, No, Dry |
| DPS | Door Position Switch | SPDT, Dry |
| LED | Tri-Color LED Red or Green | 20 mA |
| | Both on = Yellow | 40 mA |

All switches rated @ 250 mA @ 30 VDC

ELECTRICAL INSTALLATION

1. Use jacketed cable for all wire runs. Refer to the SDC wire gauge chart for proper lock power wire size (18 AWG gauge minimum).
2. Use only shielded cable for all signal wires. 22 AWG gauge (minimum) may be used for signal wires up to 1,000 feet.
3. All wires **must** be colored coded.
4. Use properly fused power source only. See Electrical Specifications.
5. Make all Emlock terminal connections according to Figure 3A or 3B.

IMPORTANT NOTES

INDOOR USE ONLY

Do not run power wires and signal wires in the same cable or conduit.

Do not install a diode in parallel with any magnetic lock. A diode will cause a delay when releasing the door and residual magnetism to occur.

Although SDC recommends the use of a DC power supply, a transformer with an adjacent mounted full wave bridge rectifier may be used. A significant voltage drop will occur when using a full wave bridge rectifier.

Any low voltage condition will cause erratic operation of the optional bond sensor.

When using a full wave bridge rectifier, all access controls and/or release contacts must be located between the Emlock and rectifier to ensure quick release.

AWG WIRE CHART

To determine the correct wire gauge to use on "one circuit" the following information is required:

1. The quantity, voltage, and current draw of all lock(s) to be used.
2. The distance in feet from the power supply to the furthest lock.

Add together the current draw (amps) of all locks on the same circuit. Cross reference the total amps with the distance between the power source and the furthest lock to determine the wire gauge required. All wiring must be installed in accordance with all state and local codes.

DISTANCE IN FEET FROM POWER SOURCE TO FARTHEST LOCKING DEVICE

	AMPS	25	50	75	100	150	200	250	300	400	500	1000
Minimum Wire Gauge for 12 Volts AC or DC	0.25	18	18	18	18	18	16	16	14	14	12	
	0.50	18	18	18	16	16	14	12				
	0.75	18	18	16	14	12						
	1.00	18	16	14	14	12						
	1.50	18	14	12	12							
	2.00	16	14	12								
2.50	16	12										

DISTANCE IN FEET FROM POWER SOURCE TO FARTHEST LOCKING DEVICE

	AMPS	25	50	75	100	150	200	250	300	400	500	1000
Minimum Wire Gauge for 24 Volts AC or DC	0.25	18	18	18	18	18	18	18	18	16	16	16
	0.50	18	18	18	18	18	16	16	14	14	12	
	0.75	18	18	18	18	16	14	14	12	12		
	1.00	18	18	16	16	14	14	12				
	1.50	18	18	16	14	14	12					
	2.00	18	16	14	14	12						
2.50	18	16	14	12								

TROUBLE SHOOTING

PROBLEM	CAUSE	SOLUTION
Emlock releases slowly. (residual magnetism)	Control switch wired on AC side of power source.	Control switch must be wired on DC side of power supply.
	Field installed diode in parallel with power input.	When an AC transformer and rectifier are used, the control switch must be wired between the rectifier and the Emlock. Remove diode.
Poor holding force.	Armature installed rigidly.	Armature must pivot loosely from its center mounting point to permit full armature contact.
	Low voltage.	Check for proper voltage at the Emlock input. If low, determine if the correct wire gauge is being used to prevent excessive voltage drop. Check power supply load capacity. It must meet or exceed the combined current rating of all locks on the circuit.
	AC voltage input. (Emlock will make a humming noise)	Emlocks require DC input voltage. When AC voltage from a transformer is used, a full wave bridge rectifier must be installed to convert the AC voltage to DC voltage.
No holding force. Door does not lock.	No power.	Check the voltage at the Emlock. If the voltage is low or zero, double check all wire connections and the power supply.
	Input polarity reversed.	Check voltage polarity. Terminal (-) is: Negative. Terminal (+) is: Positive.
	Open circuit in Emlock coil.	Check coil continuity with OHM meter. If reading is high or open, replace the magnet coil. See Fig. 3A and the Resistance Specifications.
	Magnet coil short.	Coil shorts or incorrect wiring will blow fuses. Measure the coil for correct resistance. See Fig. 3A and the Resistance specifications.

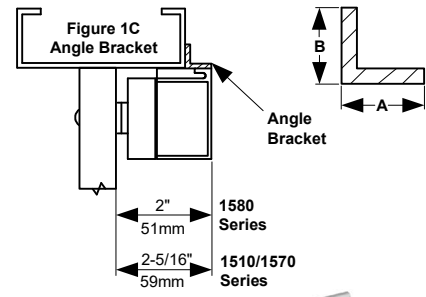
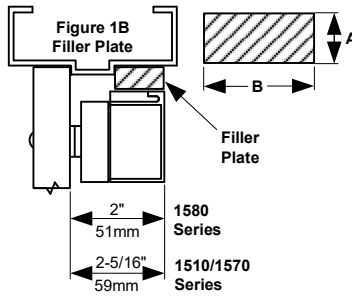
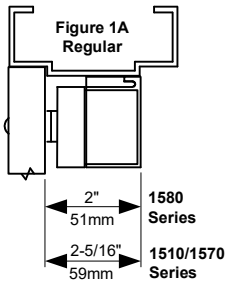

FILLER PLATES: For extension of the stop to provide a proper mounting surface on the underside of the header.
See Figure 1B.

ANGLE BRACKETS: Used as extension on shallow door frames to provide adequate mounting surface.
See Figure 1C.

FOR 1581 SINGLE EMLOCK MODELS

PART #	SIZE	A	B	} 8-3/4" (222mm)
FP01	1/8" x 1-1/4" (3 x 32mm)			
FP02	1/4" x 1-1/4" (6 x 32mm)			
FP03	3/8" x 1-1/4" (10 x 32mm)			
FP04	1/2" x 1-1/4" (13 x 32mm)			
FP05	5/8" x 1-1/4" (16 x 32mm)			

FOR 1581 SINGLE EMLOCK MODELS

PART #	SIZE	A	B	} 8-3/4" (222mm)
AB01	1" x 1" (25 x 25mm)			
AB02	1" x 1-1/2" (25 x 38mm)			
AB03	1-1/2" x 1-1/2" (38 x 38mm)			
AB04	2" x 1-1/2" (51 x 38mm)			

FOR 1511, 1571 SINGLE EMLOCK MODELS

PART #	SIZE	A	B	} 11" (279mm)
FP11	1/8" x 1-1/4" (3 x 32mm)			
FP12	1/4" x 1-1/4" (6 x 32mm)			
FP13	3/8" x 1-1/4" (10 x 32mm)			
FP14	1/2" x 1-1/4" (13 x 32mm)			
FP15	5/8" x 1-1/4" (16 x 32mm)			

FOR 1511, 1571 SINGLE EMLOCK MODELS

PART #	SIZE	A	B	} 11" (279mm)
AB11	1" x 1" (25 x 25mm)			
AB12	1" x 1-1/2" (25 x 38mm)			
AB13	1-1/2" x 1-1/2" (38 x 38mm)			
AB14	2" x 1-1/2" (51 x 38mm)			

FOR 1582 DOUBLE EMLOCK MODEL

PART #	SIZE	A	B	} 17-1/2" (445mm)
FP30	1/8" x 1-1/4" (3 x 32mm)			
FP31	1/4" x 1-1/4" (6 x 32mm)			
FP32	3/8" x 1-1/4" (10 x 32mm)			
FP33	1/2" x 1-1/4" (13 x 32mm)			
FP34	5/8" x 1-1/4" (16 x 32mm)			

FOR 1582 DOUBLE EMLOCK MODEL

PART #	SIZE	A	B	} 17-1/2" (445mm)
AB31	1" x 1" (25 x 25mm)			
AB32	1" x 1-1/2" (25 x 38mm)			
AB33	1-1/2" x 1-1/2" (38 x 38mm)			
AB34	2" x 1-1/2" (51 x 38mm)			

FOR 1512, 1572 DOUBLE EMLOCK MODELS

PART #	SIZE	A	B	} 22" (559mm)
FP21	1/8" x 1-1/4" (3 x 32mm)			
FP22	1/4" x 1-1/4" (6 x 32mm)			
FP23	3/8" x 1-1/4" (10 x 32mm)			
FP24	1/2" x 1-1/4" (13 x 32mm)			
FP25	5/8" x 1-1/4" (16 x 32mm)			

FOR 1512, 1572 DOUBLE EMLOCK MODELS

PART #	SIZE	A	B	} 22" (559mm)
AB21	1" x 1" (25 x 25mm)			
AB22	1" x 1-1/2" (25 x 38mm)			
AB23	1-1/2" x 1-1/2" (38 x 38mm)			
AB24	2" x 1-1/2" (51 x 38mm)			

• Multiple predrilled and tapped mounting holes to accommodate the use of several different locks on either 4" or 4.5" aluminum frames.

• Field adjustable for 1/2", 5/8" and 3/4" all glass Herculite doors.

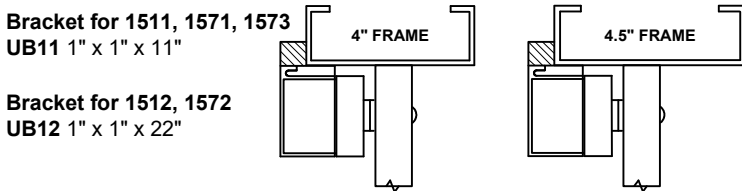

Kits for 1511, 1571, 1581
HDB1 Single
Kits for 1512, 1572, 1582
HDB2 Double

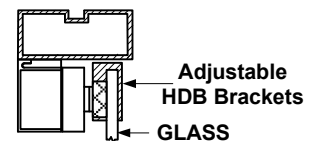

Inswing Door Kits

Kits for 1200 lb and 1650 lb locks
TJ1 Single
TJ2 Double
Kits for 650 lb locks
TJ81 Single
TJ82 Double

